

WALL + CEILING PRODUCT GUIDE 2020



HELPING BUILD NZ

PRENAIL & TRUSS / EXTERIOR CLADDING / TIMBER / STEEL STUD
INSULATION / PLASTERBOARD / ACOUSTIC CEILING TILES
/ ACCESS HATCHES / HARDWARE / FASTENERS



WORKING TOGETHER TO BUILD NZ

ROCKWOOL
Rockfon[®]

COMFAB PRODUCTS

IBS
BUILDING PRODUCTS

 **Bradford**[™]
more than insulation

 **James Hardie**

AUTEX 

FORTRESS[®]
FASTENERS

GIB[®]

Firth

Mi[™]
MiTek[™]

 **Thermakraft**[™]
INTELLIGENT MEMBRANES FOR THE BUILDING INDUSTRY

TABLE OF CONTENTS

Rockfon Stonewool Acoustic Ceilings	1
Steel Stud and Track	3-4
Wall Strapping Systems	5
Screwfix Ceiling Grid	6
Clips and Accessories	7
Sound Isolation Systems	8
Top Hat & Cladding Sections	10
Two Way Exposed Grid	11
Floor Coverings	12
Access Hatches	13-14
Plasterboard	15
Plaster Set Beads	16
CBS Aluminium Sections & Profiles	17-20
Insulation	21-22
Timber Products	23-25
Plywood	26
Pynefloor / Building Wraps	27
Cladding & Underfloor Insulation	28-30
Timber Hardware	31-32
Fasteners / Paslode Nails / Tools	33-36



ROCKFON STONEWOOL ACOUSTIC CEILING

Product	Edge options	Dimensions*	Surface	Humidity resistance	Sound absorption $\alpha_{w}/class$	NRC	Sound insulation $D_{n,f,w} (C;C_{tr})$	Reaction to fire
DESIGN WHITE								
ROCKFON® Sonar™	A15, A24, B D, E15, E24, X, M	600 - 2400	Micro-textured, white	Up to 100% RH	Up to 1.00 Class A	Up to 1.00	-	A1
DESIGN DECORATION								
ROCKFON® Color-all™	A15, A24, E24, X	600 - 600	Smooth, colour	Up to 100% RH	Up to 1.00 Class A	Up to 1.00	-	A1 A2-s1, d0 (Mercury)
BASIC WHITE								
ROCKFON® Pacific™	A15, A24, E15, E24	600 - 1200	Smooth, white	Up to 100% RH	0.80 Class B	0.80	-	A1
ROCKFON® Artic™	A15, A24, E15, E24	600 - 1200	Smooth, white	Up to 100% RH	0.90 Class A	0.85	-	A1
ROCKFON® Koral™	A15, A24, E15, E24	600 - 1800	Micro-textured, white	Up to 100% RH	Up to 0.95 Class A	Up to 0.90	-	A1
ROCKFON® Tropic™	A15, A24, E15, E24	600 - 1800	Smooth, white	Up to 100% RH	0.95 Class A	0.90	-	A1
SPECIAL AREA								
<i>Sound insulation</i>								
ROCKFON® Sonar™ dB 35	A24, E15, E24	600 - 1200	Micro-textured, white	Up to 100% RH	0.80 Class B	0.85	35 (-2;-8) dB	A1
ROCKFON® Sonar™ dB 40	A24, D, E15, E24	600 - 1200	Micro-textured, white	Up to 100% RH	0.90 Class A	0.90	40 (-2;-6) dB	A1
ROCKFON® Sonar™ dB 42	A24, D, E15, E24	600 - 1200	Micro-textured, white	Up to 100% RH	0.90 Class A	0.90	42 (-2;-7) dB	A1
ROCKFON® Sonar™ dB 44	A24, D, E15, E24	600 - 1200	Micro-textured, white	Up to 70% RH	0.90 Class A	0.90	44 (-1;-7) dB	A2-s1, d0
<i>Healthcare</i>								
ROCKFON® Hygienic / Hygienic Plus	A24	600 - 600	Micro-textured, white	Up to 100% RH	1.00 Class A	0.95	-	A1
ROCKFON® MediCare™ Std	A15, A24, E15, E24	600 - 1200	Micro-textured, white	Up to 100% RH	Up to 0.95 Class A	Up to 0.90	-	A1
ROCKFON® MediCare™ Plus	A24, E24, X	600 - 1200	Micro-textured, white	Up to 100% RH	1.00 Class A	0.95	-	A1
ROCKFON® MediCare™ Air	A24	600 - 1200	Micro-textured, white	Up to 100% RH	0.80 Class B	0.90	-	A1
<i>Impact Resistance</i>								
ROCKFON® Samson™	A24	600 - 1200	Woven, white	Up to 100% RH	Up to 1.00 Class A	Up to 1.05	-	A1
ROCKFON® Boxer™	A24	600 - 1800	Micro-textured, white	Up to 100% RH	Up to 1.00 Class A	0.95	-	A1
<i>Industry</i>								
ROCKFON® Industrial Opal / Black	A24	600 - 1200	Pre-finished surface	Up to 100% RH	Up to 1.00 Class A	Up to 1.00	-	A1
ISLANDS AND BAFFLES**								
ROCKFON® Eclipse™	A	1160-1760	Smooth, white	Up to 100% RH	See datasheet	-	-	A1
ROCKFON® Contour™	Bc	200-1200	Smooth, white	Up to 100% RH	See datasheet	-	-	A1
ROCKFON® Fibral Multiflex Baffle	Multiflex	300 - 1200	Smooth	Up to 100% RH	See datasheet	-	-	A1
WALLABSORBERS								
ROCKFON® Boxer™ wall absorbers	A24, A HAT	600 - 1800	Micro-textured, white	Up to 100% RH	See datasheet	-	-	A1
ROCKFON® Color-all™ wall absorbers	A24	600 - 2400	Smooth, colour	Up to 100% RH	See datasheet	-	-	A1
ROCKFON® Samson™ wall absorbers	A24, A HAT	600 - 2400	Woven, white	Up to 100% RH	See datasheet	-	-	A1
ROCKFON® Sonar Activity™ wall absorbers	A24, B, C	600 - 2400	Micro-textured, white	Up to 100% RH	See datasheet	-	-	A1
ROCKFON® VertiQ™ wall absorbers	A24, A HAT, C	600 - 2700	Woven, 4 colours	Up to 100% RH	See datasheet	-	-	A2-s1, d0

This table is a quick reference for comparing product characteristics, please refer to the product performance pages and product datasheets for further information.

* Smallest width to largest length available. See product pages for full details on formats.

** For islands and baffles, sound data is expressed as the Equivalent Sound Absorption Area (m^2) per single item. Data is dependent on the distance between the items.

Direct sound insulation	Reaction to fire	Light reflection	Cleaning	Bacteriological class	Clean room	Air pressure control	Impact resistance	Demountable
-	A1	85 %	Vacuum, damp cloth	-	ISO Class 5	-	-	Yes
-	A1 A2-s1,d0 (Mercury)	See datasheet	Vacuum	-	-	-	-	Yes
-	A1	82 %	Vacuum	-	-	-	-	Yes
-	A1	82 %	Vacuum	-	-	-	-	Yes
-	A1	86 %	Vacuum, damp cloth	-	-	-	-	Yes
-	A1	86 %	Vacuum	-	-	-	-	Yes
19 (-1;-3) dB	A1	85 %	Vacuum, damp cloth	-	-	-	-	Yes
21 (-1;-2) dB	A1	85 %	Vacuum, damp cloth	-	-	-	-	Yes
-	A2-s1,d0	85 %	Vacuum, damp cloth	-	-	-	-	Yes
27 (-1;-4) dB	A2-s1,d0	85 %	Vacuum, damp cloth	-	-	-	-	Yes
-	A1	85 %	Vacuum, damp cloth, steam	-	Hygienic Plus: ISO class 5	-	-	Yes
-	A1	86 %	Vacuum, damp cloth	B5, B10	ISO Class 5	-	-	Yes
-	A1	85 %	Vacuum, damp cloth, steam	B1	ISO Class 4	-	-	Yes
-	A1	85 %	Vacuum, damp cloth, steam	B1, B5	ISO Class 3	Yes	-	Yes
-	A1	72 %	Vacuum	-	-	-	Class 2A (T24 + Clips)	Yes No (with clips)
-	A1	85 %	Vacuum, damp cloth	-	-	-	20 mm: Class 3A (T24 + Clips) 40 mm: Class 2A (T24 + Clips)	Yes No (with clips)
-	A1	Opal: 64 %	Vacuum	-	-	-	-	Yes
-	A1, A2-s1, d0 (Rockfon Eclipse Rectangule 2360)	See datasheet	Vacuum	-	-	-	-	Yes
-	A1	79 %	Vacuum	-	-	-	-	Yes
-	A1	77 %	Vacuum	-	-	-	-	Yes
-	A1	85 %	Vacuum, damp cloth	-	-	-	See datasheet	Yes
-	A1, A2-s1, d0 (Mercury)	See datasheet	Vacuum	-	-	-	-	Yes
-	A1	72 %	Vacuum	-	-	-	See datasheet	Yes
-	A1	85 %	Vacuum, damp cloth	-	-	-	-	Yes
-	A2-s1,d0	See datasheet	Vacuum, damp cloth	-	-	-	See datasheet	Yes

STEEL STUD & TRACK

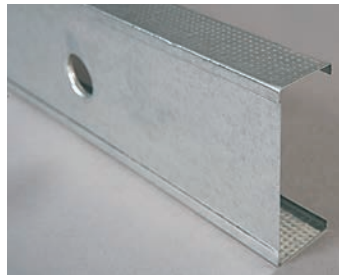

STEEL STUD SIZES

CODE	SIZES	DESCRIPTION
------	-------	-------------

WSL5050		WALL STUD LIPPED 50MM
T5030	TRACK 50MM 3.0	

0.55 BMT

WSL5563	2.4/2.8/3.0/3.6/4.2/4.8/6.0	WALL STUD LIPPED 63MM
T635030	TRACK 63MM 3.0	
WSL5575	2.4/2.8/3.0/3.6/4.2/4.8/6.0	WALL STUD LIPPED 75MM
T755530	TRACK 75MM 3.0	

WSL5592	2.4/2.8/3.0/3.6/4.2/4.8/6.0	WALL STUD LIPPED 92MM
T925530	TRACK 92MM 3.0	

WSL55150	2.4/2.8/3.0/3.6/4.2/4.8/6.0	WALL STUD LIPPED 150MM
T1505530	TRACK 150MM 3.0	

0.75 BMT

WSL7563	2.4/2.8/3.0/3.6/4.2/4.8/6.0	WALL STUD LIPPED 63MM
T637530	TRACK 63MM 3.0	

WSL7575	2.4/2.8/3.0/3.6/4.2/4.8/6.0	WALL STUD LIPPED 75MM
T757530	TRACK 75MM 3.0	

WSL7592	2.4/2.8/3.0/3.6/4.2/4.8/6.0	WALL STUD LIPPED 92MM
T927530	TRACK 92MM 3.0	

WSL75150	2.4/2.8/3.0/3.6/4.2/4.8/6.0	WALL STUD LIPPED 150MM
T1507530	TRACK 150MM 3.0	

1.15 BMT

WSL11563	2.4/2.8/3.0/3.6/4.2/4.8/6.0	WALL STUD LIPPED 63MM
T6311530	TRACK 63MM 3.0	

WSL11575	2.4/2.8/3.0/3.6/4.2/4.8/6.0	WALL STUD LIPPED 75MM
T7511530	TRACK 75MM 3.0	

WSL11592	2.4/2.8/3.0/3.6/4.2/4.8/6.0	WALL STUD LIPPED 92MM
T9211530	TRACK 92MM 3.0	

WSL115150	2.4/2.8/3.0/3.6/4.2/4.8/6.0	WALL STUD LIPPED 150MM
T15011530	TRACK 150MM 3.0	

NB: ALL SIZES CAN BE CUT TO LENGTH

DRY WALL TRACK

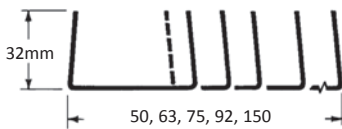
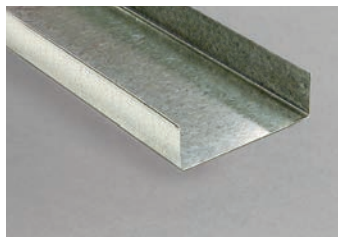

TRACK SIZES

CODE SIZES DESCRIPTION

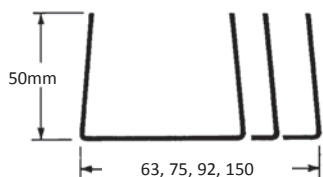
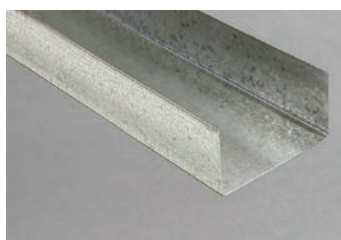

DEFLECTION HEAD TRACK SIZES

NOGGING TRACK



RESILIENT CHANNEL



FLEXIBLE TRACK



DEFLECTION HEAD TRACK

.75 BMT

CODE	SIZES	DESCRIPTION
DFT63	3.0	DEFLECTION HEAD TRACK 63MM
DFT75	3.0	DEFLECTION HEAD TRACK 75MM
DFT89	3.0	DEFLECTION HEAD TRACK 89MM
DFT92	3.0	DEFLECTION HEAD TRACK 92MM
DFT150	3.0	DEFLECTION HEAD TRACK 150MM

NOGGING TRACK

.75 BMT

CODE	SIZES	DESCRIPTION
NT634	3.6	63MM NOGGING TRACK 450 CENTRE
NT636	3.6	63MM NOGGING TRACK 600 CENTRE
NT754	3.6	75MM NOGGING TRACK 450 CENTRE
NT756	3.6	75MM NOGGING TRACK 600 CENTRE
NT924	3.6	92MM NOGGING TRACK 450 CENTRE
NT926	3.6	92MM NOGGING TRACK 600 CENTRE
NT1504	3.6	150MM NOGGING TRACK 450 CENTRE
NT1506	3.6	150MM NOGGING TRACK 600 CENTRE

RESILIENT CHANNEL

CODE	SIZES	DESCRIPTION
RS36	3.6	RESILIENT CHANNEL 3600MM

FLEXIBLE TRACK

CODE	SIZES	DESCRIPTION
FT63	3.0	63MM FLEXIBLE TRACK
FT75	3.0	75MM FLEXIBLE TRACK
FT89	3.0	89MM FLEXIBLE TRACK
FT92	3.0	92MM FLEXIBLE TRACK

WALL STRAPPING SYSTEMS

FURRING CHANNEL

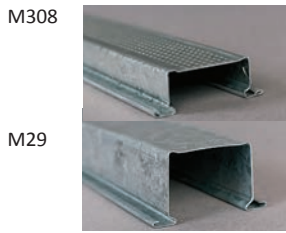

PERIMETER TRACK

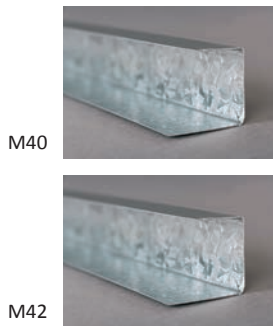

FASTENERS

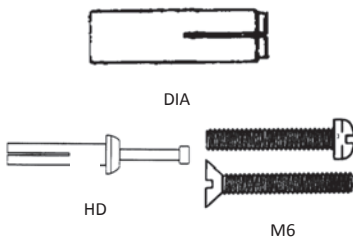

DIRECT FIX ANCHOR CLIPS FOR STRAPPING



CODE	DESCRIPTION
------	-------------

FURRING CHANNELS

M308	FURRING CHANNEL 16MM .50BMT
M29	FURRING CHANNEL 28MM .50BMT

PERIMETER TRACK

M40	FURRING CHANNEL WALL TRACK 16MM
M42	FURRING CHANNEL WALL TRACK 28MM

CODE	DESCRIPTION
------	-------------

FASTENERS

DROP IN ANCHOR

DIA	6X25MM DROP IN ANCHORS
-----	------------------------

HAMMER DRIVE

HD	HAMMER DRIVE 5 X 25MM
----	-----------------------

MACHINE SCREWS

M625MS	M6 X 25MM MACHINE SCREW
M630MS	M6 X 30MM MACHINE SCREW
M640MS	M6 X 40MM MACHINE SCREW
M650MS	M6 X 50MM MACHINE SCREW
M665MS	M6 X 65MM MACHINE SCREW

CODE	DESCRIPTION
------	-------------

DIRECT FIX ANCHOR CLIPS FOR STRAPPING

MBF	M29/308 ADJUSTABLE DIRECT FIX
MBFS	M29/308 ADJUSTABLE DIRECT FIX LONG
M237	M29/2308 WALL CLIP
M239	M29/2308 WALL CLIP THREADED
M24R	RESILIENT JOINER BRACKET
M237R	FURRING CHANNEL RESILIENT MOUNT
M48R	RESILIENT MOUNT RIGHT ANGLE BRACKET
MBFR	ADJUSTABLE DIRECT FIX FURRING CHANNEL RESILIENT MOUNT
MBFR6	ADJUSTABLE DIRECT FIX FURRING CHANNEL RESILIENT MOUNT WITH 6.5 BOLT

SCREWFIX CEILING GRID AND CLIPS

FURRING CHANNEL

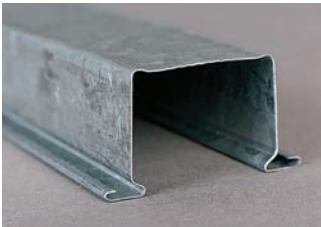
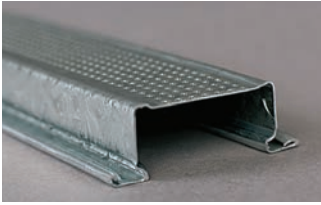

TOP CROSS RAIL

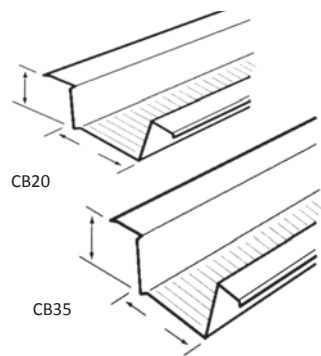
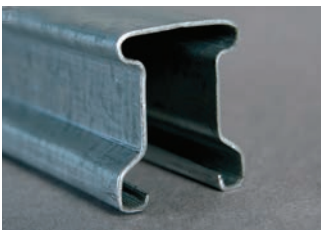

PERIMETER TRACK



SUSPENSION WIRE



CODE	DESCRIPTION
------	-------------

FURRING CHANNELS

M308	FURRING CHANNEL 16MM 3.6 / 4.8 / 6M
M29	FURRING CHANNEL 28MM 3.6 / 4.8 / 6M
CB20	FURRING CHANNEL 20MM 3.6 / 4.8 / 6M
CB35	FURRING CHANNEL 35MM 3.6 / 4.8 / 6M

PRIMARY CHANNELS

TOP CROSS RAIL

M25	TOP CROSS RAIL 25MM .55 BMT X 3.6M
M27	TOP CROSS RAIL 25MM .75 BMT X 3.6M

PERIMETER TRACK AND BACKING ANGLE

M42	FURRING CHANNEL WALL TRACK 16MM X 3M
M40	FURRING CHANNEL WALL TRACK 28MM X 3M
M35	FURRING CHANNEL WALL TRACK 35MM X 3M
BA40	BACKING ANGLE 40 X 40 .55 BMT X 3M
BA30	BACKING ANGLE 30 X 30 .55 BMT X 3M

CODE	DESCRIPTION
------	-------------

SUSPENSION WIRE

GV2.5	2.5MM WIRE X 3.6M
GV20	20 X 20 GALV ANGLE WITH SAFETY EDGE X 3M

CLIPS AND ACCESSORIES

DIRECT FIX CLIPS



M26 / M94 / M81

PRIMARY TO SECONDARY JOINERS

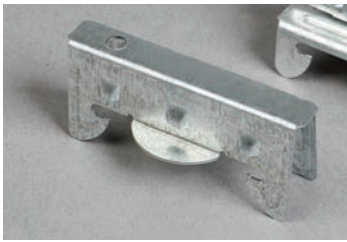

PURLIN CLIPS

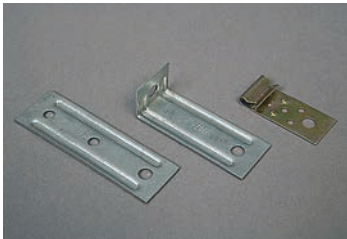

CODE	DESCRIPTION
------	-------------

DIRECT FIX CLIPS

M26	M29 / M308 DIRECT FIX SHORT
M94	M29 / M308 DIRECT FIX LONG
M81	M29 / M308 DIRECT FIX ANGLE BRACKET

PRIMARY TO SECONDARY JOINERS

M39	M29 / M308 TO M27 / M28 LOCKING KEY
-----	-------------------------------------

PURLIN CLIPS

M74	ROD BRACKET
M47	RIGHT ANGLE ROD BRACKET
MVF	PURLIN CLIP

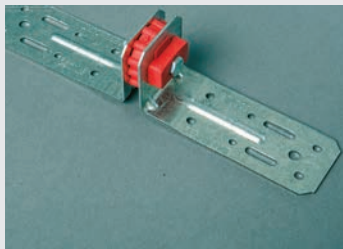
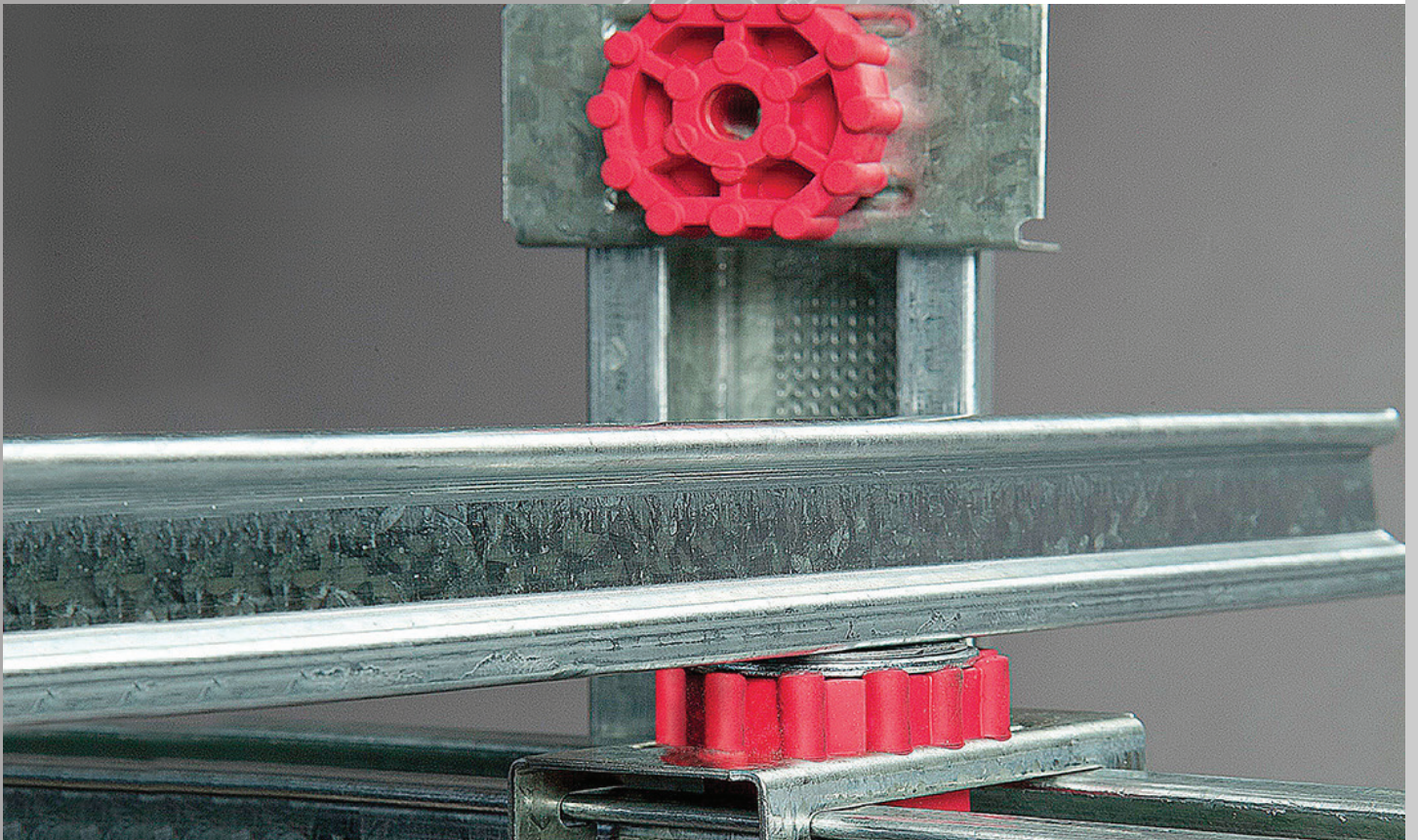

M24R RESILIENT JOINER BRACKET

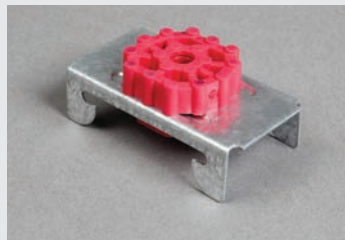

M237R DIRECT FIX FURRING CHANNEL RESILIENT MOUNT

M237R

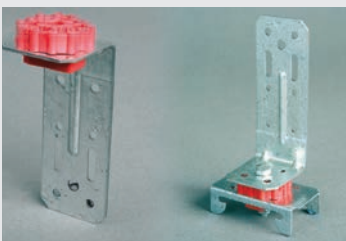

M48R RESILIENT MOUNT ANGLE BRACKET

M96R FURRING CHANNEL TO PURLIN RESILIENT MOUNT

M48R

M96R



M23TR FURRING CHANNEL TO TOP CROSS RAIL RESILIENT MOUNT

M23R



M50R-BLK 54KG RESILIENT ISOLATION HANGER

M50R-RED 29KG RESILIENT ISOLATION HANGER

M50R-BLU 91KG RESILIENT ISOLATION HANGER

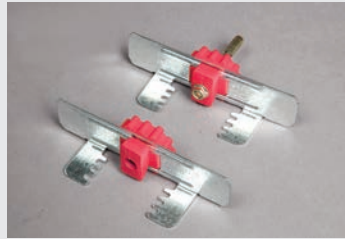

MBFR ADJUSTABLE DIRECT FIX FURRING CHANNEL RESILIENT MOUNT

MBFR ADJUSTABLE DIRECT FIX FURRING CHANNEL RESILIENT MOUNT WITH DYNABOLT

M3FR ADJUSTABLE

WORKING TOGETHER TO BUILD NZ



TOP HAT & CLADDING SECTIONS

JUNCTION STUDS

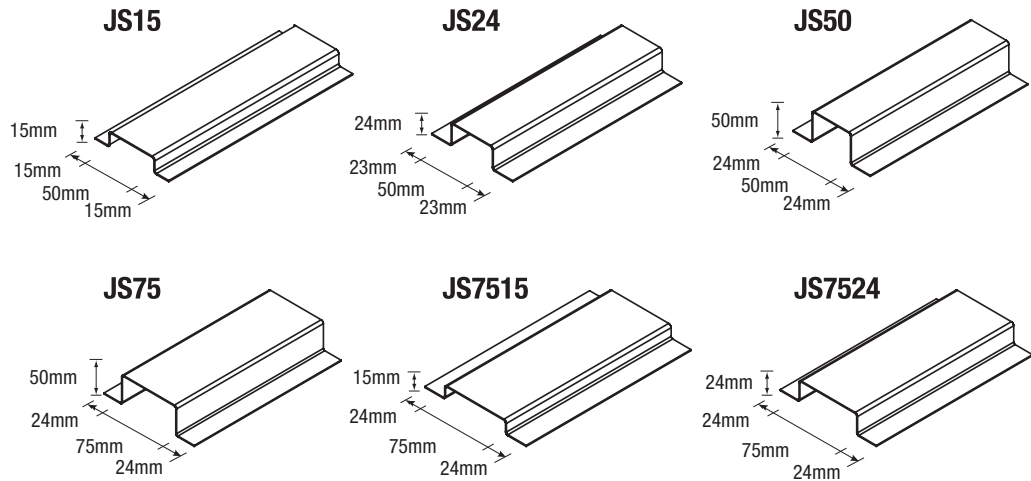

CODE

DESCRIPTION

JUNCTION STUDS

JS15	JUNCTION STUD 15MM X 50MM X 1.15TCT
JS24	JUNCTION STUD 24MM X 50MM X 1.15TCT
JS50	JUNCTION STUD 35MM X 50MM X 1.15TCT
JS75	JUNCTION STUD 35MM X 75MM X 1.15TCT
JS7515	JUNCTION STUD 15MM X 75MM X 1.15TCT
JS7524	JUNCTION STUD 24MM X 75MM X 1.15TCT

TOP HAT

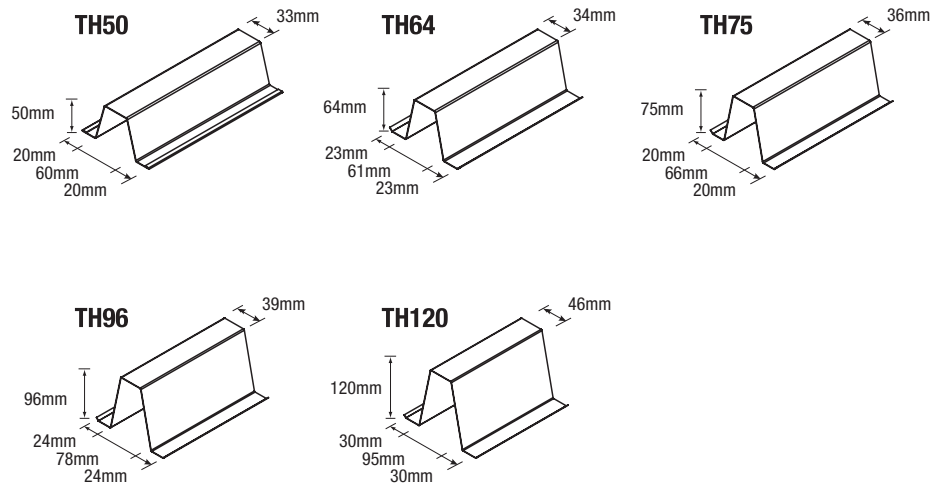

TH50	TOP HAT 50MM X 0.75BMT
TH64	TOP HAT 64MM X 0.75BMT
TH75	TOP HAT 75MM X 0.75BMT
TH96	TOP HAT 96MM X 0.75BMT
TH120	TOP HAT 120MM X 0.75BMT

TWO WAY EXPOSED CEILING GRID



WALL ANGLES



WT36 / WTL36 / SWT36

ALUMINIUM

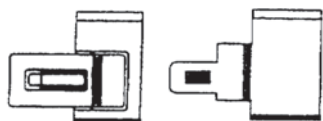

ACT2412/15



ACT246/15

WALL ANGLES

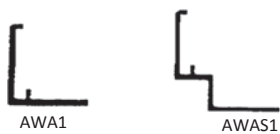

AWA1

AWAS1



BT1

AWA2



AWAS2

BT2

CURVED SECTIONS



WAC

WASC

CODE	DESCRIPTION
TWO WAY EXPOSED CEILING GRID (24MM)	
MR2436	MAINRUNNER 24MM X 3600
CT2412	CROSS TEE RUNNER 24MM X 1200
CT246	CROSS TEE 24MM X 600
TWO WAY EXPOSED CEILING GRID (15MM)	
MR1536	MAINRUNNER 15MM X 3600
CT1512	CROSS TEE RUNNER 15MM X 1200
CT6156	CROSS TEE 15MM X 600
WALL ANGLES	
WT36	PERIMETER WALL TRIM 3600
WTL36	PERIMETER WALL TRIM LONG LEG 3600
SWT36	SHADOWLINE WALL TRIM 3600
ALUMINIUM GRID	
ALUMINIUM TWO WAY EXPOSED CEILING GRID (24MM)	
AMR2436	ALUMINIUM 24MM X 37MM X 3600 WHITE
ACT2412	ALUMINIUM 24MM X 37MM X 1200 WHITE
ACT246	ALUMINIUM 24MM X 22MM X 600 WHITE
ALUMINIUM TWO WAY EXPOSED CEILING GRID (15MM)	
AMR1536	ALUMINIUM 3600 POWDERCOATED WHITE
ACT1512	ALUMINIUM 1200 POWDERCOATED WHITE
ACT156	ALUMINIUM 600 POWDERCOATED WHITE
WALL ANGLES	
AWA1	ALUMINIUM WALL ANGLE 19 X 19 MM X 3600
AWAS1	ALUMINIUM REVERSIBLE 19 X 9 X 19 MM X 3600
BT1	ALUMINIUM BULKHEAD 25 X 11 MM X 4000
AWA2	ALUMINIUM WALL ANGLE 19 X 19 MM REVERSIBLE 3600
AWAS2	ALUMINIUM REVERSIBLE 19 X 9 X 19 MM X 3600
BT2	ALUMINIUM BULKHEAD 25 X 11 MM X 3600
CURVED SECTIONS	
WAC	ALUMINIUM ANGLE 19 X 19 CURVED X 3600
WASC	ALUMINIUM SHADOWLINE ANGLE CURVED X 3600



PRODUCT CODE	DESCRIPTION	DIMENSION
AM-1501	Antimar Impact Protecta 1m	1mm 1m x 30m
AM-1502120050	Antimar Impact Protecta 2 mm	2mm x 1.2m x 50m
AM-1504120050-A	Antimar Impact Protecta 4mm	4mm x 1.2m x 50m
B180MR	Buffalo Board	1m x 50m
PR1000.30	Protecta Board 1m x 30m	1m x 30m
AM-130	Grey Recycled Rubber 1.2m x 20	1200mm x 20m
AM-131	Grey Recycled Rubber 1m x 25m	1m x 25m
IPF-800	Polweave Carpet Saver	2m x 50m
FL100030	Spillshield Felt 1m x 30m	1m x 30m
FP700-80.1.100	Carpet Saver 1m x 100m	80mu 1m x 100m
FP700-80.500.100	Carpet Saver 500mm x 100m	80mu 500mm x 100m
FP700-100.1.100	Carpet Saver 1m x 100m	100mu 1m x 100m
IPF-550-TM	Tacky Dust Mat	910mm x 600mm
IPF-550-TMU	Tacky Dust Mat	1200mm x 900mm
AM-202	Flute Board White 2.5mm	2.5mm 1.8m x 1.2m
AM-205	Flute Board White 3mm	3mm 2.4m x 1.2m
AM-203	Flute Board White 5mm	5mm 1.8m x 1.2m
AM-204	Flute Board White 5mm	5mm 2.4m x 1.2m
AM-100	Corner Protectors	50mm x 50mm x 2m
AMT-120R	Foam Tube Large red	120mm x 2m
AMT-80Y-C	Foam Tube Yellow medium	80mm x 2m
AM-110	Antimar Corrogate Cardboard	1200mm x 75m
AM-145	Antimar Airobubble 1300mmx60m	1300mm x 60m
IPF-S91348	Aluminium Protection Tape	48mm x 66m
IPF-S91372	Aluminium Protection Tape	72mm x 66m
IPF-S91396	Aluminium Protection Tape	96mm x 66m
FP700-101220100	Block Out Film	1220mm x 100m
IPF-530N	Kiwk-Fix Demolition Film	500mm x 50m
TDP-200	Temporary Down Pipe	200mm x 50m
DSC-50	Double Stick Tape	50mm x 10m
MPC-24B	Hand Tearable Cloth Tape Blue	24mm x 25m
MPC-48B	Hand Tearable Cloth Tape Blue	48mm x 25m
MPC-48BLK	Hand Tearable Cloth Tape Black	48mm x 25m
MPC-48R	Hand Tearable Cloth Tape Red	48mm x 25m
MPC-48S	Hand Tearable Cloth Tape Silver	48mm x 25m
MPC-48W	Hand Tearable Cloth Tape White	48mm x 25m
MPC-4850B-A	Hand Tearable Cloth Tape Blue	48mm x 50m
DT-48	All Purpose Duct Tape	48mm x 30m
IPF-S470048-A	Orange PVC Exterior Masking	48mm x 50m

ACCESS HATCHES

AP/CFR1

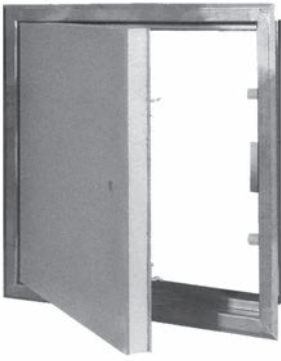

APT



APT/WW

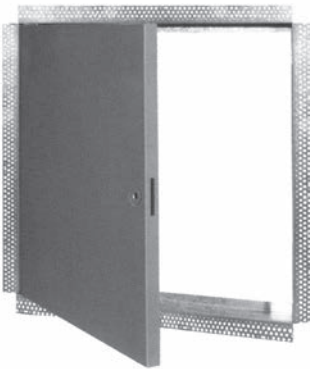

THE HATCH

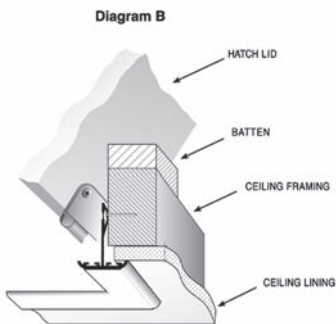

CODE	DESCRIPTION
------	-------------

NON RATED METAL - FEATHER EDGE

APT/H/FE	ACCESS PANEL 450 X 450
APT/H/FE	ACCESS PANEL 550 X 550
APT/H/FE	ACCESS PANEL 600 X 600
APT/H/FE	ACCESS PANEL 1200 X 600

NON RATED METAL - SETTING BEAD

APT/WW-H	ACCESS PANEL 150 X 150
APT/WW-H	ACCESS PANEL 250 X 250
APT/WW-H	ACCESS PANEL 300 X 300
APT/WW-H	ACCESS PANEL 450 X 450
APT/WW-H	ACCESS PANEL 550 X 550
APT/WW-H	ACCESS PANEL 600 X 600
APT/WW-H	ACCESS PANEL 1200 X 600

NON RATED METAL TIP LATCH - FEATHER EDGE

APT/H/FE-TL	ACCESS PANEL 300 X 300 TIP LATCH
APT/H/FE-TL	ACCESS PANEL 450 X 450 TIP LATCH
APT/H/FE-TL	ACCESS PANEL 550 X 550 TIP LATCH
APT/H/FE-TL	ACCESS PANEL 600 X 450 TIP LATCH
APT/H/FE-TL	ACCESS PANEL 600 X 600 TIP LATCH

NON RATED METAL TIP LATCH - SETTING BEAD

APT/WW-H/TL	ACCESS PANEL 300 X 300 TIP LATCH
APT/WW-H/TL	ACCESS PANEL 450 X 450 TIP LATCH
APT/WW-H/TL	ACCESS PANEL 550 X 550 TIP LATCH
APT/WW-H/TL	ACCESS PANEL 600 X 450 TIP LATCH
APT/WW-H/TL	ACCESS PANEL 600 X 600 TIP LATCH

SOUND RATED METAL PANELS STC 30 - SETTING BEADS

APT/WW-H/STC30	ACCESS PANEL 300 X 300 STC 30
APT/WW-H/STC30	ACCESS PANEL 450 X 450 STC 30
APT/WW-H/STC30	ACCESS PANEL 550 X 550 STC 30
APT/WW-H/STC30	ACCESS PANEL 600 X 600 STC 30

SOUND RATED METAL PANELS STC 30 - FEATHER EDGE

APT/H/STC30	ACCESS PANEL 300 X 300 STC 30
APT/H/STC30	ACCESS PANEL 450 X 450 STC 30
APT/H/STC30	ACCESS PANEL 550 X 550 STC 30
APT/H/STC30	ACCESS PANEL 600 X 600 STC 30

THE HATCH

PR03	ACCESS HATCH FRAME ONLY 300 X 300
------	-----------------------------------

ACCESS HATCHES

APC/WW

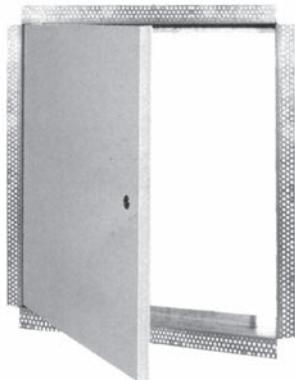

APC/WW/TL

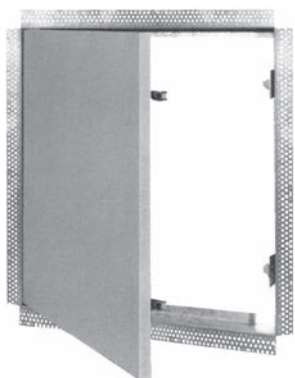

AP/EC2

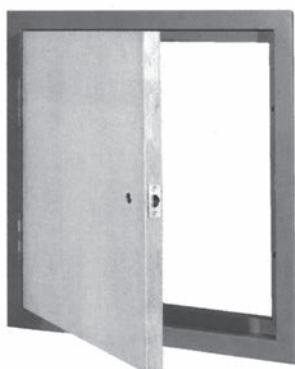

CODE	DESCRIPTION
------	-------------

NON RATED MDF - SETTING BEAD

APC/WW-H	ACCESS PANEL 300 X 300
APC/WW-H	ACCESS PANEL 450 X 450
APC/WW-H	ACCESS PANEL 550 X 550
APC/WW-H	ACCESS PANEL 600 X 600

NON RATED MDF - FEATHER EDGE

APC/FE-H	ACCESS PANEL 300 X 300
APC/FE-H	ACCESS PANEL 450 X 450
APC/FE-H	ACCESS PANEL 550 X 550
APC/FE-H	ACCESS PANEL 600 X 600

NON RATED MDF TIP LATCH - SETTING BEAD

APC/WW-H/TL	ACCESS PANEL 300 X 300 TIP LATCH
APC/WW-H/TL	ACCESS PANEL 450 X 450 TIP LATCH
APC/WW-H/TL	ACCESS PANEL 550 X 550 TIP LATCH
APC/WW-H/TL	ACCESS PANEL 600 X 600 TIP LATCH

NON RATED MDF TIP LATCH - FEATHER EDGE

APC/FE-H/TL	ACCESS PANEL 300 X 300 TIP LATCH
APC/FE-H/TL	ACCESS PANEL 450 X 450 TIP LATCH
APC/FE-H/TL	ACCESS PANEL 550 X 550 TIP LATCH
APC/FE-H/TL	ACCESS PANEL 600 X 600 TIP LATCH

SOUND RATED PANELS MDF STC 30 SETTING BEAD

APC/WW/30	ACCESS PANEL 300 X 300 STC 30
APC/WW/30	ACCESS PANEL 450 X 450 STC 30
APC/WW/30	ACCESS PANEL 550 X 550 STC 30
APC/WW/30	ACCESS PANEL 600 X 600 STC 30

SOUND RATED PANELS MDF STC 30 FEATHER EDGE

APC/FE/30	ACCESS PANEL 300 X 300 STC 30
APC/FE/30	ACCESS PANEL 450 X 450 STC 30
APC/FE/30	ACCESS PANEL 550 X 550 STC 30
APC/FE/30	ACCESS PANEL 600 X 600 STC 30

CEILING FIRE RATED 1 HOUR SETTING BEAD

APC/FR1/WW	ACCESS PANEL 300 X 300 1HR FIRE RATED
APC/FR1/WW	ACCESS PANEL 450 X 450 1HR FIRE RATED
APC/FR1/WW	ACCESS PANEL 600 X 600 1HR FIRE RATED

CEILING FIRE RATED 1 HOUR FEATHER EDGE

APC/FR1/FE	ACCESS PANEL 300 X 300 1HR FIRE RATED
APC/FR1/FE	ACCESS PANEL 450 X 450 1HR FIRE RATED
APC/FR1/FE	ACCESS PANEL 600 X 600 1HR FIRE RATED

PLASTERBOARD

10MM STD	
PRICE M2	LENGTH
	2400
	2700
	3000
	3300
	3600
	4200
	4800
	6000

13MM STD	
PRICE M2	LENGTH
	2400
	2700
	3000
	3300
	3600
	4200
	4800
	6000

10MM STANDARD TE/SE	
PRICE M2	LENGTH
	2400
	3000
	3300
	3600
	4200
	4800
	6000

10MM AQUALINE	
LENGTH	
	2400
	2700
	3000
	3600

13MM AQUALINE	
LENGTH	
	2400
	2700
	3000
	3600

10MM BRACELINE / NOISELINE	
LENGTH	
	2400
	2700
	3000
	3600
	4800

10MM WIDELINE TE/SE	
LENGTH	
	3600
	4800
	6000

13MM TOUGHLINE	
LENGTH	
	2400
	2700
	3000
	3600

10MM FYRELINE	
LENGTH	
	2400
	2700
	3000
	3600

13MM FYRELINE	
LENGTH	
	2400
	2700
	3000
	3300
	3600

10MM ULTRALINE	
LENGTH	
	3600
	4800
	6000

13MM ULTRALINE PLUS	
LENGTH	
	3000
	3600
	4800
	6000

13MM ULTRALINE PLUS 1350MM	
LENGTH	
	4800

13MM BRACE/NOISE	
LENGTH	
	2400
	2700
	3000
	3300
	3600



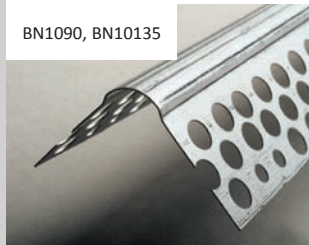
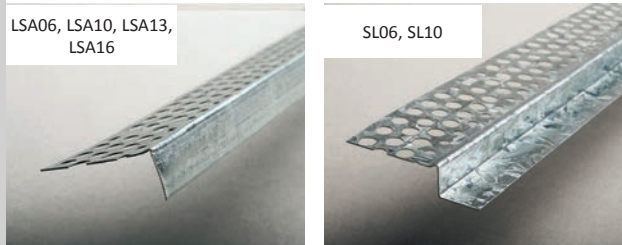
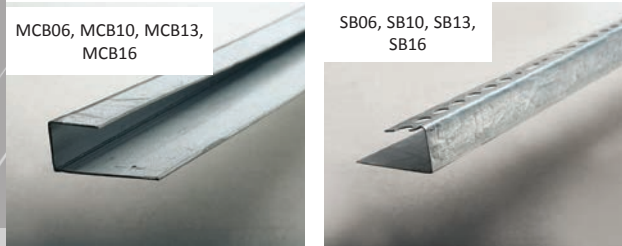
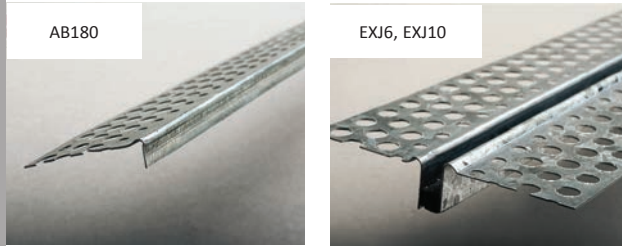
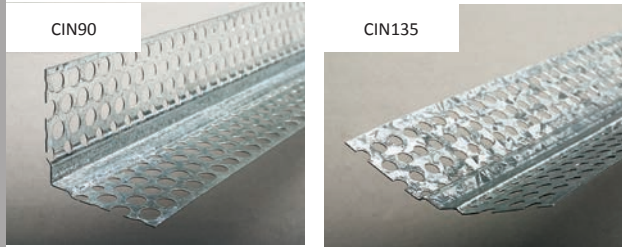

CODE DESCRIPTION

PLASTER SET BEADS



























CEX 90	EXT 90 DEGREE PLASTERBOARD SETTING ANGLE
CEX 135	EXT 135 DEGREE PLASTERBOARD SETTING ANGLE
CIN 90	INT 90 DEGREE PLASTERBOARD SETTING ANGLE
CIN 135	INT 135 DEGREE PLASTERBOARD SETTING ANGLE

AB180	ARCH BEAD
EXJ6	6MM CONTROL JOINT
EXJ10	10MM CONTROL JOINT
MCB06	6MM METAL CASING BEAD
MCB10	10MM METAL CASING BEAD
MCB13	13MM METAL CASING BEAD
MCB16	16MM METAL CASING BEAD
SB06	6MM STOPPING BEAD
SB10	10MM STOPPING BEAD
SB13	13MM STOPPING BEAD
SB16	16MM STOPPING BEAD
LSA06	6MM LONG LEG STOPPING ANGLE
LSA10	10MM LONG LEG STOPPING ANGLE
LSA13	13MM LONG LEG STOPPING ANGLE
LSA16	16MM LONG LEG STOPPING ANGLE
SSA10	10MM SHORT LEG STOPPING ANGLE
SSA13	13MM SHORT LEG STOPPING ANGLE









SL10 10MM SHADOWLINE





BN1090	EX90 DEGREE BULLNOSE 10MM RADIUS
BN10135	EX135 DEGREE BULLNOSE 10MM RADIUS









ALUMINIUM SECTIONS & PROFILES

		HEADSECTIONS	Lgth
	CBS 400 DL	64mm Headsection Standard 13mm Linings each side	5.6
	CBS 405 DL	64mm Headsection Flush Face 13mm Linings each side	5.6
	CBS 407 DL	64mm Shadowline Headsection 13mm Linings each side	5.6
	CBS 408 MLS	64mm Headsection 3 x 13mm Linings	5.6
	CBS 420 AL92	92mm Headsection 13mm Linings each side	5.6
	CBS 900 AL92	92mm Headsection Flush Face 13mm Linings each side	5.6
	CBS 904 AL92	92mm Shadowline Headsection 13mm Linings each side	5.6
	CBS 907 MLS	92mm Headsection 4 x 13mm Linings	5.6
	CBS 909 MLS	92mm Headsection 3 x 13mm Linings	5.6
		POCKET SECTIONS	Lgth
	CBS 411 MLS	Triple layer pocket mullion 64mm (use w CBS 408 / 412)	5.6
	CBS 412 MLS	Triple layer pocket starter cap 64mm (use w CBS 408 / 411)	5.6
	CBS 413 MLS	Triple layer pocket headsection 64mm	5.6
	CBS 543 AL64	Alement 64 Pocket starter cap	5.6
	CBS 544 AL64	Alement 64 Mullion section (rq's CBS 543)	5.6
	CBS 546 AL64	Alement 64 Pocket headsection	5.6
	CBS 890 AL92	Alement 92 Pocket headsection	5.6
	CBS 891 AL92	Alement 92 Mullion section	5.6
	CBS 892 AL92	Alement 92 Pocket starter cap	5.6
		SKIRTINGS / TRIMS	Lgth
	CBS 130 All	25mm x 4.5mm Flat bar	5.6
	CBS 132 All	2 Piece 25mm Skirting back	2.8
	CBS 135 All	2 Piece 25mm Skirting cover / front	2.8
	CBS 325 All	13mm Gib lining cap	5.6
	CBS 356 All	120mm Skirting (rq's insert)	2.8
	CBS 601 All	100mm Skirting (rq's insert)	2.8
	CBS 602 All	150mm Skirting (rq's insert)	2.8
	CBS 906 All	13mm Shadowline gib lining cap	5.6
		GLAZING BARS / BEADS / CHANNELS	Lgth
	CBS 205 DL	45mm Glazing bar - standard (rq's CBS 215)	5.6
	CBS 210 DL	45mm Glazing bar - with leg (rq's CBS 215)	5.6
	CBS 215 DL	45mm Glazing bead (fits CBS 205 / 210 / 225 / 315 / 680)	5.6
	CBS 225 DL	45mm Transom bar (rq's 2 x CBS 215)	5.6
	CBS 235 DL	45mm 3 way glazing section	5.6
	CBS 315 DL	45mm Pillar post (rq's CBS 215)	5.6
	CBS 320 DL	25mm x 25mm Glazing channel	5.6
	CBS 540 AL64	25mm x 25mm Glazing bar (rq's CBS 541)	5.6
	CBS 541 AL64	25mm x 25mm Glazing bead	5.6
	CBS 562 AL64	50mm x 25mm Glazing bar (rq's CBS 563)	5.6
	CBS 563 AL64	50mm x 25mm Glazing bead	5.6
	CBS 588 AL64	103mm x 25mm Glazing bar (rq's CBS 587)	5.6

			GLAZING BARS / BEADS / CHANNELS CONT...	Lgth
	CBS 587	AL64	103mm x 25mm Glazing bead	5.6
	CBS 607	AL64	Transom / Mullion fixed bead (rq's 1 x CBS 608)	5.6
	CBS 608	AL64	103mm Transom bead	5.6
	CBS 609	AL64	103mm Transom bar (rq's 2 x CBS 608)	5.6
	CBS 680	AL64	45mm x 125mm Glazing bar (rq's CBS 215)	5.6
	CBS 893	AL92	132mm x 25mm Transom bar (rq's 2 x CBS 894)	5.6
	CBS 894	AL92	132mm x 25mm Transom bead	5.6
	CBS 895	AL92	132mm x 25mm Glazing bar (rq's CBS 896)	5.6
	CBS 896	AL92	132mm x 25 Glazing bead	5.6

			DOOR JAMBS / STOPS / POSTS	Lgth
	CBS 300	DL	45mm x 45mm post	5.6
	CBS 305	DL	45mm Door jamb - 40mm door	5.6
	CBS 310	DL	45mm Door jamb - 50mm door	5.6
	CBS 315	DL	45mm Pillar post (rq's CBS 215)	5.6
	CBS 538	AL64	103mm Multi post for 64mm stud	5.6
	CBS 545	AL64	Pocket door stop 40mm door	5.6
	CBS 547	AL64	Pocket door stop 50mm door	5.6
	CBS 897	AL92	132mm Multi post for 92mm stud	5.6
	Mohair & Seals		Mohair & Seal selection - Pocket door stop 40 to 50mm door	5.6

			CAPS / INFILLS	Lgth
	CBS 125	DL	Grooved starter cap (fits CBS 400 / 405 / 546 / 544)	5.6
	CBS 537	AL64	103mm flush start cap (fits CBS 400 / 405 / 546 / 544)	5.6
	CBS 648	All	Pocket infill	5.6
	CBS 745	ALP	Neg. Det. Flush Cap for CBS 740	5.6
	CBS 898	AL93	132mm flush starter cap (fits CBS 420 / 900 / 890 / 891)	5.6

			NEGATIVE DETAIL SECTIONS	Lgth
	CBS 740	ALP	13mm high Neg. Det. Headsection - 13mm/64mm/13mm	5.6
	CBS 742	ALP	40mm high Neg. Det. Floor track - 13mm/64mm/13mm	5.6
	CBS 749	ALP	80mm Neg. Det Floor track - 13mm/64mm/13mm	5.6
	CBS 754	ALP	25mm high Neg. Det Floor track - 13mm/64mm/13mm	5.6
	CBS 757	ALP	13mm high Neg. Det. Floor track - 64mm / 3x13mm	5.6
	CBS 741	ALP	13mm high Neg. Det. Headsection -13mm/90mm/13mm	5.6
	CBS 747	ALP	40mm high Neg. Det. Floor track -13mm/90mm/13mm	5.6
	CBS 756	ALP	25mm high Neg. Det. Floor track - 13mm/90mm/13mm	5.6
	CBS 758	ALP	25mm high Neg. Det. Floor track - 64mm Stud / 3x13mm	5.6

ALUMINIUM SECTIONS & PROFILES

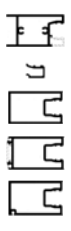
75MM DOOR SECTIONS				Lgth
	CBS 605	ALD	75mm Top/Bottom Rail (rq's CBS 610)	2.8
	CBS 610	ALD	Bead to suit Top/Bottom Rail	2.8
	CBS 615	ALD	75mm Hinge Stile - Hinged Door	2.8
	CBS 620	ALD	75mm Lockset Stile - hinged and Sliding Door (rq's CBS 640)	2.8
	CBS 625	ALD	75mm Closing Stile - Sliding Door	2.8
	CBS 640	ALD	Infill for Closing Stile	2.8

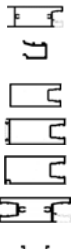

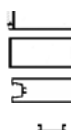

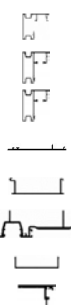
100MM DOOR SECTIONS				Lgth
	CBS 645	ALD	100mm Top/Bottom Rail (rq's CBS 610)	2.8
	CBS 610	ALD	Bead to suit Top/Bottom Rail	2.8
	CBS 655	ALD	100mm Hinge Stile - Hinged Door	2.8
	CBS 660	ALD	100mm Lockset Stile - Hinged and Sliding Door (rq's CBS 640)	2.8
	CBS 665	ALD	100mm Closing Stile - Sliding Door	2.8
	CBS 670	ALD	100mm Transom (rq's CBS 610)	2.8
	CBS 640	ALD	Infill for Closing Stile	2.8

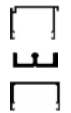









125 / 150MM DOOR SECTIONS				Lgth
	CBS 672	ALD	125mm Lockset Stile - Hinged and Sliding Door (rq's CBS 640)	2.8
	CBS 673	ALD	125mm Hinge Stile	2.8
	CBS 776	ALD	150mm Transom (rq's CBS 610)	2.8
	CBS 640	ALD	Infill for Closing Stile	2.8

CBS SLIDING DOOR SYSTEM				Lgth
	CBS 350	ALSD	Head unit light weight (rq's 60kg track & CBS 351)	4.0
	CBS350180	ALSD	Head unit body with built-in 180kg track (rq's CBS 351)	4.0
	CBS350180	ALSD	Head unit body with built-in 180kg track (rq's CBS 351)	6.0
	CBS 351	ALSD	Pelmet (for CBS 350 / 350-180 / 357)	4.0
	CBS 352	ALSD	Pelmet Closer (to CBS 350 / 350-180 / 351)	4.0
	CBS 353	ALSD	Vertical Starter	3.0
	CBS 355	ALSD	Vertical Closer (fits CBS 353)	3.0
CBS 357	ALSD	Pelmet clip (rq's CBS 351)	4.0	

BOTTOM ROLLER GEAR				Lgth
	CBS 1000		Mating head good for multi stack bottom roller doors	5.0
	CBS 1001		Bottom roller track	5.0
	CBS 1002		Non mating head guide for bottom roller door, also a vertical	5.0
	HDR		Heavy duty roller, only fits CBS 645 rail	each

Most items are ex stock in mill finish and satin anodised finish, powder coating has a lead time. Also check out our Brio sliding door systems on the next page. We do straight top or bottom rollers as well as bifolds and multistacking door systems.

		NEGATIVE DETAIL BEADS	Lgth
	CBS 746 ALP	40mm high Negative detail one-sided bead	5.6
	CBS 750 ALP	13mm high Negative detail one-sided bead	5.6
	CBS 752 ALP	80mm high Negative detail one-sided bead	5.6
	CBS 755 ALP	25mm high Negative detail one-sided bead	5.6
	CBS 760 ALP	13mm high Negative detail ceiling trim	5.6

		64MM DOUBLE AND FRONT GLAZE	Lgth
	CBS 800	64mm Headsection Flush	5.6
	CBS 801	64mm Double Glazed Pocket Headsection	5.6
	CBS 802	64mm Double Glazed Pocket starter	5.6
	CBS 804	Front Glaze Double Glazing Bar	5.6
	CBS 805	Front Glaze Double Glazing Bead 1 centre	5.6
	CBS 806	Front Glaze Double Glazing Bead 2 outer	5.6
	CBS 807	64mm Front single Glazed Pocket Headsection	5.6
	CBS 808	64mm Front single Glazed Pocket Starter cap	5.6
	CBS 809	Front Glaze single Glazing Bar	5.6
	CBS 810	Front Glaze single Glazing Bead	5.6

		92MM DOUBLE AND FRONT GLAZE	Lgth
	CBS 811	92mm Headsection Flush	5.6
	CBS 812	92mm Double Glazed Pocket headsection	5.6
	CBS 813	92mm Double Glazed Pocket starter	5.6
	CBS 815	92mm Front Glaze Double Glazing Bar	5.6
	CBS 816	92mm Front Glaze Double Glazing Bead 1 centre	5.6
	CBS 817	92mm Front Glaze Double Glazing Bead 2 outer	5.6
	CBS 818	92mm Front single Glazed Pocket headsection	5.6
	CBS 819	92mm Front single Glazed Pocket starter cap	5.6
	CBS 822	92mm Front Glaze single Glazing Bar	5.6
	CBS 823	92mm Front Glaze single Glazing Bead	5.6

Most items are ex stock in mill finish and satin anodised finish, powder coating has a lead time.
 Also check out our Brio sliding door systems on the next page. We do straight top or bottom rollers as well as bifolds and multistacking door systems.





Polyester Insulation List - Zone N1

Product Code	Product Description	Piece Size (mm) (L x W x T) (Nominal)	Total Area per Pack (m ²) (Nominal)	Pieces per Bale	Pck	Stock Category	Minimum Order Quantity
Ceiling Pads							
711801	Greenstuf® R2.9 Ceiling Pad	1220 x 430 x 175	6.8	13		A	1
711802	Greenstuf® R3.2 Ceiling Pad	1220 x 430 x 180	6.8	13		A	1
711803	Greenstuf® R3.4 Ceiling Pad	1220 x 430 x 190	5.2	10		A	1
Wall Pads							
711815	Greenstuf® Wall R2.0 360mm	1160 x 360 x 90	8.35	20		A	1
711804	Greenstuf® Wall R2.0 560mm	1160 x 560 x 90	11.69	18		A	1
711816	Greenstuf® Wall R2.2 360mm	1160 x 360 x 90	7.52	18		A	1
711805	Greenstuf® Wall R2.2 560mm	1160 x 560 x 90	11.69	18		A	1
711817	Greenstuf® Wall R2.5 360mm	1160 x 360 x 90	5.01	12		A	1
711806	Greenstuf® Wall R2.5 560mm	1160 x 560 x 90	6.5	10		A	1
Underfloor							
711811	Greenstuf® R1.5 Underfloor 450mm	8900 x 450 x 100	20	5		A	1
711812	Greenstuf® R1.5 Underfloor 500mm	10000 x 500 x 100	20	4		A	1
711825	Greenstuf® R1.5 Underfloor 600mm	8340 x 600 x 100	20	4		A	1
711813	Greenstuf® R1.8 Underfloor 450mm	7780 x 450 x 100	17.5	5		B	1
711826	Greenstuf® R1.8 Underfloor 500mm	8750 x 500 x 100	17.5	4		B	1
711814	Greenstuf® R1.8 Underfloor 600mm	7290 x 600 x 100	17.5	4		B	1
Masonry Wall							
711818	Greenstuf® Masonry Wall R0.5	25420 x 590 x 20	30	2		B	1
711876	Greenstuf® Masonry Wall R1.0	12930 x 580 x 45	30	4		B	1
711819	Greenstuf® Masonry Wall R1.3	2400 x 580 x 45	8.35	6		B	1
Thermal Rolls							
711877	Greenstuf® Roll R1.0 870mm	10350 x 870 x 45	30	2		C	9
711820	Greenstuf® Roll R1.5 870mm	14400 x 870 x 100	25	2		C	10
711878	Greenstuf® Roll R1.8 580mm	10780 x 580 x 100	25	4		B	1
711807	Greenstuf® Roll R1.8 870mm	14370 x 870 x 100	25	2		B	1
711879	Greenstuf® Roll R2.2 580mm	8620 x 580 x 150	20	4		B	1
711821	Greenstuf® Roll R2.2 870mm	11500 x 870 x 150	20	2		B	1
711822	Greenstuf® Roll R2.4 870mm	11500 x 870 x 140	20	2		C	13
711880	Greenstuf® Roll R2.6 580mm	8620 x 580 x 140	20	4		B	1
711823	Greenstuf® Roll R2.6 870mm	9770 x 870 x 140	17	2		B	1
711881	Greenstuf® Roll R2.9 580mm	7330 x 580 x 185	17	4		B	1
711808	Greenstuf® Roll R2.9 870mm	9770 x 870 x 185	17	2		A	1
711882	Greenstuf® Roll R3.2 580mm	7330 x 580 x 190	17	4		B	1
711809	Greenstuf® Roll R3.2 870mm	9770 x 870 x 190	17	2		A	1
711883	Greenstuf® Roll R3.4 580mm	7330 x 580 x 200	17	4		B	1
711824	Greenstuf® Roll R3.4 870mm	7470 x 870 x 200	13	2		B	1
711810	Greenstuf® Roll R3.6 870mm	8050 x 870 x 210	14	2		A	1
Building Insulation Blanket (BIB)							
711831	Greenstuf® BIB Roll R1.0 1200mm	16670 x 1200 x 42	20	1		C	13
711832	Greenstuf® BIB Roll R1.5 1200mm	10830 x 1200 x 100	13	1		C	20
711833	Greenstuf® BIB Roll R1.8 1200mm	10830 x 1200 x 100	13	1		C	20
711834	Greenstuf® BIB Roll R2.2 1200mm	10420 x 1200 x 150	12.5	1		C	20
711835	Greenstuf® BIB Roll R2.6 1200mm	7500 x 1200 x 140	9	1		C	28
711836	Greenstuf® BIB Roll R3.2 1200mm	7500 x 1200 x 190	9	1		C	28
711837	Greenstuf® BIB Roll R3.4 1200mm	6670 x 1200 x 200	8	1		C	32
Skillion Roof Blanket (SRB)							
711827	Greenstuf® Skillion Roof Blanket R2.9	2400 x 870 x 115	8.35	4		B	1
711828	Greenstuf® Skillion Roof Blanket R3.2	2400 x 870 x 165	8.35	4		B	1
711829	Greenstuf® Skillion Roof Blanket R3.4	2400 x 870 x 165	8.35	4		B	1
711830	Greenstuf® Skillion Roof Blanket R3.6	2400 x 870 x 165	8.35	4		B	1

Thermal Wall & Ceiling Segment

Code	R Value	Dimensions (mm)	Area m ²	Coverage m ²	Pieces	NRC Value
84836	R1.8 Wall	1160 x 580 x 90	14.8	16.6	22	0.85
84838	R2.2 Wall	1160 x 580 x 90	10.8	12.1	16	1.05
104734	R2.4 Wall	1160 x 580 x 90	6.7	7.6	10	
86961	R2.6 Wall	1160 x 580 x 90	5.4	6	8	1.10
118544	R2.8 Wall	1160 x 580 x 90	3.4	3.8	5	
126862	R3.5 Wall	1160 x 580 x 140	6.7	7.6	10	
125449	R4.0 Wall	1160 x 580 x 140	3.4	3.8	5	
38199	R1.8 Ceiling	1160 x 430 x 95	12	13.5	24	
15237	R2.7 Ceiling	1160 x 430 x 145	10	11.2	20	1.00
84832	R3.2 Ceiling	1160 x 430 x 165	8	9	16	1.05
84833	R3.6 Ceiling	1160 x 430 x 185	7	7.8	14	
84834	R4.0 Ceiling	1160 x 430 x 215	6	6.7	12	
79716	R5.0 Ceiling	1160 x 430 x 210	4	4.5	8	
79717	R6.0 Ceiling	1160 x 430 x 260	3	3.4	6	

Thermal Blanket

Code	R Value	Dimensions (mm)	Area m ²	NRC Value
15555	R1.3 Blanket	30m x 1200 x 60	36	0.80
62631	R1.8 Blanket	15m x 1200 x 80	18	0.85
85808	R2.2 Blanket	15m x 1200 x 90	18	
60353	R2.6 Blanket	10m x 1200 x 120	12	
110112	R2.9 Blanket	8m x 1200 x 115	9.6	
85807	R3.2 Blanket	10m x 1200 x 145	12	

Acoustic

Code	R Value	Dimensions (mm)	Area m ²	Coverage m ²	Pieces	NRC Value
89731	Acoustic Gold R1.8	1160 x 580 x 75	10.8	12.1	16	0.92
118332	Acoustic Gold R2.2	1160 x 580 x 90	10.8	12.1	16	1.05

Thermal & Acoustic Underfloor | Midfloor

Code	R Value	Dimensions (mm)	Area m ²	Coverage m ²	Pieces	NRC Value
108742	Optimo R2.6	1160 x 415 x 90	3.8	4.3	8	1.10
108741	Optimo R2.6	1160 x 565 x 90	5.2	5.9	8	1.10

- Prices are GST exclusive
 Freight charged on orders under 10 and site deliveries

TIMBER PRODUCTS

CODE	DESCRIPTION	UNIT
STRUCTURAL TIMBER		
MACHINE GRADED PINE (MGP) KILN DRIED RADIATA		
MSG875/50H1.2	MSG8 75X50 H1.2 SG8 RANDOM KD	LM
MSG8100/50H1.2	MSG8 100X50 H1.2 SG8 RANDOM KD	LM
MSG8150/50H1.2	MSG8 150X50 H1.2 SG8 RANDOM KD	LM
MSG8200/50H1.2	MSG8 200X50 H1.2 SG8 RANDOM KD	LM
MSG8250/50H1.2	MSG8 250X50 H1.2 SG8 RANDOM KD	LM
MG8300/50H1.2	MSG8 300X50 H1.2 SG8 RANDOM KD	LM
MSG875/50H3.2	MSG8 75X50 H3.2 SG8 RANDOM KD	LM
MSG8100/50H3.2	MSG8 100X50 H3.2 SG8 RANDOM KD	LM
MSG8150/50H3.2	MSG8 150X50 H3.2 SG8 RANDOM KD	LM
MSG8200/50H3.2	MSG8 200X50 H3.2 SG8 RANDOM KD	LM
MSG8250/50H3.2	MSG8 250X50 H3.2 SG8 RANDOM KD	LM
MG8300/50H3.2	MSG8300X50 H3.2 SG8 RANDOM KD	LM
MSG875/50H3.2	MSG8 75X50 H3.2 WET GAUGED RANDOM	LM
MSG8100/50H3.2	MSG8 100X50 H3.2 WET GAUGED RANDOM	LM
MSG8150/50H3.2	MSG8 150X50 H3.2 WET GAUGED RANDOM	LM
MSG8200/50H3.2	MSG8 200X50 H3.2 WET GAUGED RANDOM	LM
MSG8250/50H3.2	MSG8 250X50 H3.2 WET GAUGED RANDOM	LM
MSG8300/50H3.2	MSG8 300X50 H3.2 WET GAUGED RANDOM	LM
SQUARE DRESSED BOARDS		
CLEAR BOARDS		
50X25UT	50X25MM (40X18) RAD CLEARS UT DR KD	LM
75X25UT	75X25MM (65X19) RAD CLEARS UT DR KD	LM
100X25UT	100X25MM (90X19) RAD CLEARS UT DR KD	LM
150X25UT	150X25MM (135X19) RAD CLEARS UT DR KD	LM
200X25UT	200X25MM (180X18) RAD CLEARS UT DR KD	LM
250X25UT	250X25MM (230X18) RAD CLEARS UT DR KD	LM
300X25UT	300X25MM (280X18) RAD CLEARS UT DR KD	LM
75X25H3	75X25MM (65X19) RAD CLEARS H3.1 DR KD	LM
100X25H3	100X25MM (90X19) RAD CLEARS H3.1 DR KD	LM
150X25H3	150X25MM (135X19) RAD CLEARS H3.1 DR KD	LM
200X25H3	200X25MM (180X18) RAD CLEARS H3.1 DR KD	LM
250X25H3	250X25MM (230X18) RAD CLEARS H3.1 DR KD	LM
300X25H3	300X25MM (280X18) RAD CLEARS H3.1 DR KD	LM

TIMBER PRODUCTS

CODE	DESCRIPTION	UNIT
FJ BOARDS		
50X25 FJ PP	50X25MM (40X18) RAD H3 FJ D PP	LM
75X25 FJ PP	75X25MM (65X19) RAD H3 FJ D PP	LM
100X25 FJ PP	100X25MM (90X19) RAD H3 FJ D PP	LM
150X25 FJ PP	150X25MM (135X19) RAD H3 FJ D PP	LM
200X25 FJ PP	200X25MM (180X18) RAD H3 FJ D PP	LM
WET TIMBER		
100 X 100	FENCE POST 100 X 100 # 1 WET H4 CCA RS	LM
100 X 75	FENCE POST 100 X 75 # 1 WET H4 CCA RS	LM
100 X 100	100 X 100 # 1 WET H5 CCA RS	LM
100 X 75	100 X 75 # 1 WET H5 CCA RS	LM
100 X 100	100 X 100 #1 WET H5 CCA GAUGED	LM
100 X 75	100 X 75 #1 WET H5 CCA GAUGED	LM
TIMBER CLADDING AND DECKING		
TIMBER CLADDING		
150X25BBWB	150 X 25MM BEVEL BACK W/BOARD RAD H3.1 FJ PP	LM
250X40F	250 X 40MM FASCIA RAD H3.1 FJ PP	LM
200X20BBWB	200 X 25MM BEV BAC W/BOARD RAD H3.1 FJ PP	LM
250X25F	250 X 25MM FASCIA RAD H3.1 FJ PP	LM
150X25F	150 X 25MM FASCIA RAD H3.1 FJ PP	LM
200X25F	200 X 25MM FASCIA RAD H3.1 FJ PP	LM
150X40F	150 X 40MM FASCIA RAD H3.1 FJ PP	LM
200X40F	200 X 40MM FASCIA RAD H3.1 FJ PP	LM

TIMBER PRODUCTS

CODE	DESCRIPTION
------	-------------

TIMBER DECKING

100X40P	100 X 40MM PREM DECK H3.2 CCA
100X40MERC	100 X 40MM MERCH DECK H3.2 CCA 88 X 32
100X25 P	100 X 25MM RAD PREM DECK H3.2CCA
150X40K	150 X 40MM PREM DECK H3.2 CCA

POLES AND POSTS

POST

HOUSE PILES

900	HOUSE PILE SQUARE H5 900MM 125 X 125MM
1200	HOUSE PILE SQUARE H5 1200MM 125 X 125MM
1500	HOUSE PILE SQUARE H5 1500MM 125 X 125MM
1800	HOUSE PILE SQUARE H5 1800MM 125 X 125MM
2400	HOUSE PILE SQUARE H5 2400MM 125 X 125MM
3000	HOUSE PILE SQUARE H5 3000MM 125 X 125MM
3600	HOUSE PILE SQUARE H5 3600MM 125 X 125MM

LANDSCAPING

RETAINING WALLS

150 X 40	150 X 40MM NO 2 H4 RS RETAINING WALL
150 X 50	150 X 50MM NO 2 H4 RS RETAINING WALL
200 X 50	200 X 50MM NO 2 H4 RS RETAINING WALL

CODE	DESCRIPTION
PLYWOOD	
CDUN7MM	UNTREATED CD F8 PLYWOOD 2.4 X 1.2 X 7MM
CDUN9MM	UNTREATED CD F8 PLYWOOD 2.4 X 1.2 X 9MM
CDUN12MM	UNTREATED CD F8 PLYWOOD 2.4 X 1.2 X 12MM
CDUN15MM	UNTREATED CD F8 PLYWOOD 2.4 X 1.2 X 15MM
CDUN18MM	UNTREATED CD F8 PLYWOOD 2.4 X 1.2 X 18MM
CDUN21MM	UNTREATED CD F8 PLYWOOD 2.4 X 1.2 X 21MM
CDUN25MM	UNTREATED CD F8 PLYWOOD 2.4 X 1.2 X 25MM
DDUN7MM	UNTREATED DD F8 PLYWOOD 2.4 X 1.2 X 7MM
DDUN9MM	UNTREATED DD F8 PLYWOOD 2.4 X 1.2 X 9MM
DDUN12MM	UNTREATED DD F8 PLYWOOD 2.4 X 1.2 X 12MM
DDUN15MM	UNTREATED DD F8 PLYWOOD 2.4 X 1.2 X 15MM
DDUN18MM	UNTREATED DD F8 PLYWOOD 2.4 X 1.2 X 18MM
DDUN21MM	UNTREATED DD F8 PLYWOOD 2.4 X 1.2 X 21MM
DDUN25MM	UNTREATED DD F8 PLYWOOD 2.4 X 1.2 X 25MM
CDT7MM	TREATED CD F8 PLYWOOD 2.4 X 1.2 X 7MM
CDT9MM	TREATED CD F8 PLYWOOD 2.4 X 1.2 X 9MM
CDT12MM	TREATED CD F8 PLYWOOD 2.4 X 1.2 X 12MM
CDT15MM	TREATED CD F8 PLYWOOD 2.4 X 1.2 X 15MM
CDT17MM	TREATED CD F8 PLYWOOD 2.4 X 1.2 X 18MM
CDT21MM	TREATED CD F8 PLYWOOD 2.4 X 1.2 X 21MM
CDT25MM	TREATED CD F8 PLYWOOD 2.4 X 1.2 X 25MM
DDT7MM	TREATED DD F8 PLYWOOD 2.4 X 1.2 X 7MM
DDT9MM	TREATED DD F8 PLYWOOD 2.4 X 1.2 X 9MM
DDT12MM	TREATED DD F8 PLYWOOD 2.4 X 1.2 X 12MM
DDT15MM	TREATED DD F8 PLYWOOD 2.4 X 1.2 X 15MM
DDT18MM	TREATED DD F8 PLYWOOD 2.4 X 1.2 X 18MM
DDT21MM	TREATED DD F8 PLYWOOD 2.4 X 1.2 X 21MM
DDT25MM	TREATED DD F8 PLYWOOD 2.4 X 1.2 X 25MM



PYNEFLOOR / BUILDING WRAPS

CODE	DESCRIPTION
PARTICLE BOARD	
FLOORING	
PYN 36X20	STRANDFLOOR 3600 X 1200 X 20MM UT T&G
PYN 36X20	STRANDFLOOR 3600 X 1200 X 20MM H3 T&G
BUILDING WRAPS	
WGP2740100	WATERGATE PLUS 2740 X 365 100SQM
WGP2740050	WATERGATE PLUS 2740MM 50SQM
WGP1370100	WATERGATE PLUS 1370MM 100SQM
WGP1370050	WATERGATE PLUS 1370MM 50SQM
WGP1370025	WATERGATE PLUS 1370MM 25SQM
TEKWRAP2740	TEKTON HOUSEWRAP 2740 X 37 (101M2)
DPC5020	DAMP PROOF COURSE 50MM X 30M
DPC7520	DAMP PROOF COURSE 75MM X 30M
DPC9020	DAMP PROOF COURSE 90MM X 30M
DPC15020	DAMP PROOF COURSE 150MM X 30M
DPC20020	DAMP PROOF COURSE 200MM X 30M
SPC05020	TRADECOURSE 500 DPC 50MM X 30M
SPC07520	TRADECOURSE 500 DPC 75MM X 30M
SPC09020	TRADECOURSE 500 DPC 90MM X 30M
SPC010020	TRADECOURSE 500 DPC 100MM X 30M
SPC15020	TRADECOURSE 500 DPC 150MM X 30M
SPC20020	TRADECOURSE 500 DPC 200MM X 30M
SPC25020	TRADECOURSE 500 DPC 250MM X 30M
SPC30020	TRADECOURSE 500 DPC 300MM X 30M
WINDOW FLASHING	
ALU075025	ALUBAND FLASHING TAPE 75 X 25
ALU150010	ALUBAND FLASHING TAPE 150 X 10
ALU150025	ALUBAND FLASHING TAPE 150 X 25
ALU200025	ALUBAND FLASHING TAPE 200 X 25
PROTECTO	SUPERSTICK 75 X 23M
PROTECTO	SUPERSTICK 150 X 23M
PROTECTO	SUPERSTICK 200 X 23M
DAMP PROOF COURSE	
SPC05030	SUPERCOURSE500 50MM X 30M
SPC07530	SUPERCOURSE500 75MM X 30M
SPC09030	SUPERCOURSE500 90MM X 30M
SPC10030	SUPERCOURSE500 100MM X 30M
SPC15030	SUPERCOURSE500 150MM X 30M
SPC20030	SUPERCOURSE500 200MM X 30M
SPC25030	SUPERCOURSE500 250MM X 30M
SPC30030	SUPERCOURSE500 300MM X 30M

CODE	DESCRIPTION
LINEA WEATHERBOARD	
401847	LINEA WEATHERBOARD 16MM 4200 X 180 PRIMED
403533	LINEA WEATHERBOARD 16MM 4200 X 150 PRIMED
401844	LINEA WEATHERBOARD 16MM 4200 X 135 PRIMED
301185	LINEA WEATHERBOARD 135MM ALUM EXT SOAKER 90
301196	LINEA WEATHERBOARD 135MM SS EXT SOAKER 90
302820	LINEA WEATHERBOARD 150MM ALUM EXT SOAKER 90
302821	LINEA WEATHERBOARD 150MM SS EXT SOAKER 90
301186	LINEA WEATHERBOARD 180MM ALUM EXT SOAKER 90
301188	LINEA WEATHERBOARD 180MM COPP EXT SOAKER 90
301197	LINEA WEATHERBOARD 180MM SS EXT SOAKER 90
301178	LINEA WEATHERBOARD 180MM ALU EXT SOAKER 135
301195	LINEA WEATHERBOARD ALU EXT SLIM BOX COR 2700
301203	LINEA WEATHERBOARD PVC 2 FLASHING 2700
301184	LINEA WEATHERBOARD ALU INT COR MOULD 90 2700
303745	JAMES HARDIE CORNER UNDERFLASHING 3000M
302490	UPVC VENT STIP 75MM X 18MM X 3M
302782	FLAT HEAD SS 316 NAIL 60 X 3.15MM (5KG)
302784	HOT DIP GALV NAIL 60 X 3.15MM (5KG)
AXENT TRIM	
401930	AXENT TRIM 16MM 2600 X 100 PRIMED
401943	AXENT TRIM 16MM 2600 X 84 PRIMED
AXENT FASCIA	
402230	AXENT FASCIA 16MM 4200 X 230 PRIMED
401843	AXENT FASCIA 16MM 4200 X 180 PRIMED

CLADDING

CODE	DESCRIPTION
HARDIFLEX SHEET	
400168	HARDIFLEX SHEET 6MM 3000 X 1200
400170	HARDIFLEX SHEET 6MM 2700 X 1200
400172	HARDIFLEX SHEET 6MM 2400 X 1200
400174	HARDIFLEX SHEET 6MM 1800 X 1200
400176	HARDIFLEX SHEET 6MM 2400 X 900
400178	HARDIFLEX SHEET 7.5MM 3000 X 1200
400179	HARDIFLEX SHEET 7.5MM 2700 X 1200
400180	HARDIFLEX SHEET 7.5MM 2400 X 1200
TILE AND SLATE UNDERLAY	
403341	TILE AND SLATE UNDERLAY 6MM 1800 X 1200
400418	TILE AND SLATE UNDERLAY 6MM 1800 X 900
404110	TILE AND SLATE UNDERLAY 6MM 1800 X 600
HARDIPANEL COMPRESSED SHEET	
400094	HARDIPANEL COMPRESSED SHEET 18MM 2400 X 1200
400096	HARDIPANEL COMPRESSED SHEET 18MM 1800 X 1200
VILLABOARD	
400427	VILLABOARD LINING 6MM 3000 X 1200 REC 2 SIDES
400428	VILLABOARD LINING 6MM 2700 X 1200 REC 2 SIDES
400429	VILLABOARD LINING 6MM 2400 X 1200 REC 2 SIDES
400432	VILLABOARD LINING 6MM 2400 X 1200 REC 4 SIDES
400442	VILLABOARD LINING 6MM 3000 X 1200 SQ/ED 4 SIDES
400444	VILLABOARD LINING 6MM 2400 X 1200 SQ/ED 4 SIDES
400434	VILLABOARD LINING 9MM 3000 X 1200 REC 2 SIDES
400435	VILLABOARD LINING 9MM 2700 X 1200 REC 2 SIDES
400436	VILLABOARD LINING 9MM 2400 X 1200 REC 2 SIDES
400439	VILLABOARD LINING 9MM 2400 X 1200 REC 4 SIDES
400059	VILLABOARD LINING 9MM 3000 X 1200 SQ/ED 4 SIDES
400445	VILLABOARD LINING 9MM 2400 X 1200 SQ/ED 4 SIDES

CODE	DESCRIPTION
HARDIFLEX EAVES LINING	
400183	HARDIFLEX EAVES LINING 4.5MM 3000 X 1200
400185	HARDIFLEX EAVES LINING 4.5MM 2700 X 1200
400187	HARDIFLEX EAVES LINING 4.5MM 2400 X 1200
400190	HARDIFLEX EAVES LINING 4.5MM 1800 X 1200
400194	HARDIFLEX EAVES LINING 4.5MM 2400 X 900
HARDISOFFIT LINING	
401946	HARDI SOFFIT LINING 4.5MM 2400 X 750
401947	HARDI SOFFIT LINING 4.5MM 2400 X 600
401948	HARDI SOFFIT LINING 4.5MM 2400 X 450
ECLIPSA EAVES LINING	
402493	ECLIPSA EAVES LINING 4.5MM 2400 X 1200
402491	ECLIPSA EAVES LINING 4.5MM 2400 X 600
HOMERAB PRE-CLADDING	
404766	4.5MM 2450 X 1200
404768	4.5MM 2750 X 1200
RAB BOARD	
402981	6MM 3000 X 1200
402980	6MM 2450 X 1200
CLD STRUCTURAL CAVITY BATTEN	
403870	19MM X 70MM X 2450MM
ACCESSORIES FOR CLD STRUCTURAL CAVITY BATTEN	
304651	FLASHING ALUMINIUM 75MM
304652	CORNER FLASHING ALUMINIUM
STRIA CLADDING	
404263	14MM 4200 X 405
HARDIEGROOVE LINING	
400245	7.5MM 2700 X 1200 100 CTR LGTH
400246	7.5MM 2400 X 1200 100 CTR LGTH

TIMBER HARDWARE

CODE	DESCRIPTION
------	-------------

ACCESSORIES FOR ECLIPSA/HARDIEFLEX/HARDIESOFFIT

300632	FASTFIX (XMAS TREES) WHITE PUC (100/BAG)
300733	HARDIEJOINTER 5MM X 3000
300729	HARDIEJOINTER 5MM X 2400
300919	PVC SOFFIT JOINTER 5MM X 450
300920	PVC SOFFIT JOINTER 5MM X 600
300921	PVC SOFFIT JOINTER 5MM X 750
300915	SOFFIT 4.5MM PVC 2 WAY JOINTER 2400
300916	SOFFIT SCOTIA MOULD PVC 2400 2PC BASE & CAP
300538	HARDIEFLEX PVC CAP MOULD 5MM 2400
300848	HARDIEFLEX PVC EXTERNAL CORNER 5MM 3000
300846	HARDIEFLEX PVC EXTERNAL CORNER 5MM 2400
300868	HARDIEFLEX PVC INTERNAL CORNER 5MM 3000
300866	HARDIEFLEX PVC INTERNAL CORNER 5MM 2400
300767	50MM INTERNAL 3259 BLACK (50M ROLL)

MITEK

2T4	TYLOK PLATE 2T4 (350)
4T5S	TYLOK PLATE 4T5 (160)
6T5S	TYLOK PLATE 6T5 (80)
8T5S	TYLOK PLATE 8T5 (80)
4T10S	TYLOK PLATE 4T10 (120)
6T10S	TYLOK PLATE 6T10S (80)
8T15S	TYLOK PLATE 8TT15 S (40)
10T15S	TYLOK PLATE 10T5S (20)
SB30T	STRIP BRACE 30M + TENS
SB10T	STRIP BRACE 10M + TENS
SBS3	SHT BR STRAP 300MM (100)
SBS4	SHT BR STRAP 400MM (100)
SBS6	SHT BR STRAP 600MM (100)
SNS	STRAP NAIL S (150)
JH4790	JOIST HANGER 47 X 90 (60)
JH47120	JOIST HANGER 47 X 120 (60)
JH47190	JOIST HANGER 47 X 190 (40)
JH95	JOIST HANGER 95 X 165 (20)
MGS	MULTIGRIP SMALLBOX (100)
WDLH	WIRE DOG LH (400)
WDRH	WIRE DOG RH (400)
WDS	WIRE DOG STAPLE (400)
CT200LH	CEILING TILE 200 LH (50)
CT200RH	CEILING TIE 200 RH (50)
CT160LH	CLEATS CT 160 LH HDG
CT160RH	CLEATS CT 160 RH HDG

CODE	DESCRIPTION
MITEK continued	
CT600	CYCLONE TIE 600MM (50)
CPC40	CONC PURLIN CLT 40 (60)
CPC80	CONC PURLIN 80 (30)
LG	LITTLE GRIPPER (500)
12KN	12KN PILE FIXING STD (4)
12KNH	12KN PILE FIXINGHIGH (10)
6KNH	6KN PILE FIXING HIGH (10)
PN3005	NAIL 30 X 3.15 5KG BOX
PN4501	SP R1 45 X 3.551KG BAG
SC3514EG	ELECTROPLT GOLD 35 X 144G T17
BLUESCREW	LUMBERLOCK BLUE SCREW (250)
SBP	6 STUD-BTM PLATE FIX (5)

BRACKETS

B25	B25 POST + BEARER (12) BOX
B28	B28 POST + BEARER (6) BOX
B35	B35 T STRAP (5 BDL)
B38	B38 T STRAP (5)
B45	B45 L STRAP (5 BDL)
B48	B48 L STRAP (5 BDL)
B50	B50 ANGLE BRKT (20)
B51	B51 ANGLE BRKT (20)
B55	B55 ANGLE BRKT (5)
B58	B58 ANGLE BRKT (5)
B65	B65 ANGLE BRKT (4)
B75	B75 RAG END (10)
B78	B78 RAG END (10)
B85	B85 STRAP (14)
B88	B88 STRAP (12)
B132	B132 POST + BEARER BRKT (8)
B135	B135 POST + BEARER BRKT (8)
B138	B138 POST + BEARER BRKT (6)
B175	B175 ANGLE BRKT (10)
B195	B195 POST + BEARER BRKT (8)
B350	B350 ANGLE BRKT (20)
B351	B351 ANGLE BKT (20)
B553	B553 ANGLE BRKT (20)
B554	B554 ANGLE BR (20)
B555	B555 ANGLE BRKT (5)

FASTENERS

CODE	DESCRIPTION
FASTENERS	
BNM1265G	M12X65 ENG BOLT/NUT GALV
BNM1280G	M12X80 ENG BOLT/NUT GALV
BNM12100G	M12X100 ENG BOLT/NUT GALV
BNM12120G	M12X120 ENG BOLT/NUT GALV
BNM12130G	M12X130 ENG BOLT/NUT GALV
BNM12140G	M12X140 ENG BOLT/NUT GALV
BNM12150G	M12X150 ENG BOLT/NUT GALV
BNM12160G	M12X160 ENG BOLT/NUT GALV
BNM12180G	M12X180 ENG BOLT/NUT GALV
BNM12200G	M12X200 ENG BOLT/NUT GALV
BNM12220G	M12X220 ENG BOLT/NUT GALV
BNM10100G	M10X100 ENG BOLT/NUT GALV
BNM10110G	M10X110 ENG BOLT/NUT GALV
BNM10300G	M10X130 ENG BOLT/NUT GALV
BNM10400G	M10X150 ENG BOLT/NUT GALV
BNM10500G	M10X180 ENG BOLT/NUT GALV
WM10G	M10X25X3 ROUND WASHERS GALV
WM12G	M12X28X3 ROUND WASHERS GALV
WM12G	M12X50X50X3 WASHERS SQUARE GALV
NHFSM10G	M10 HEX FULL NUTS GALV
NHFSM12G	M12 HEX FULL NUTS GALV
CSM1040G	10MM X 40 COACH SCREWS GALV
CSM1050G	10MM X 50 COACH SCREWS GALV
CSM1065G	10MM X 65 COACH SCREWS GALV
CSM1075G	10MM X 75 COACH SCREWS GALV
CSM1090G	10MM X 90 COACH SCREWS GALV
CSM10100G	10MM X 100 COACH SCREWS GALV
CSM10120G	10MM X 120 COACH SCREWS GALV
CSM10130G	10MM X 130 COACH SCREWS GALV
CSM10150G	10MM X 150 COACH SCREWS GALV
CSM10160G	10MM X 160 COACH SCREWS GALV
CSM10180G	10MM X 180 COACH SCREWS GALV
CSM1240G	12MM X 40 COACH SCREWS GALV
CSM1255G	12MM X 50 COACH SCREWS GALV
CSM1265G	12MM X 65 COACH SCREWS GALV
CSM1275G	12MM X 75 COACH SCREWS GALV
CSM1290G	12MM X 90 COACH SCREWS GALV
CSM12100G	12MM X 100 COACH SCREWS GALV
CSM12120G	12MM X 120 COACH SCREWS GALV
CSM12130G	12MM X 130 COACH SCREWS GALV
CSM12150G	12MM X 150 COACH SCREWS GALV
CSM12160G	12MM X 180 COACH SCREWS GALV

CODE	DESCRIPTION
FASTENERS	
CFTBG1280	12 X 80 THROUGH BOLT GALV
CFTBG12100	12 X 100 THROUGH BOLT GALV
CFTBG12120	12 X 120 THROUGH BOLT GALV
CFTBG12135	12 X 135 THROUGH BOLT GALV
CFTBG12180	12 X 180 THROUGH BOLT GALV
CFTBG16105	16 X 105 THROUGH BOLT GALV
CFTBG16125	16 X 125 THROUGH BOLT GALV
CFTBG16140	16 X 140 THROUGH BOLT GALV
CFTBG16180	16 X 180 THROUGH BOLT GALV
CFSAG1050	10 X 50 SLEEVE ANCHOR HEX HD GALV
CFSAG1060	10 X 60 SLEEVE ANCHOR HEX HD GALV
CFSAG1075	10 X 75 SLEEVE ANCHOR HEX HD GALV
CFSAG1260	12 X 60 SLEEVE ANCHOR HEX HD GALV
CFSAG1275	12 X 75 SLEEVE ANCHOR HEX HD GALV
CFSAG12100	12 X 100 SLEEVE ANCHOR HEX HD GALV
CFSAG12130	12 X 130 SLEEVE ANCHOR HEX HD GALV



FASTENERS

CODE	DESCRIPTION	UNIT	PRICE
FASTENERS			
SFQ820J	8G X 20 SUREFAST CSK SQDR Z/C JAR		
SFQ825J	8G X 25 SUREFAST CSK SQDR Z/CJAR		
SFQ832J	8G X 32 SUREFAST CSK SQDR Z/C JAR		
SFQ840J	8G X 40 SUREFAST CSK SQDR Z/C JAR		
SFQ845J	8G X 45 SUREFAST CSK SQDR Z/C JAR		
SFQ850J	8G X 50 SUREFAST CSK SQDR Z/C JAR		
SFQ865J	8G X 65 SUREFAST CSK SQDR Z/C JAR		
SFQ1050J	10G X 50 SUREFAST CSK SQDR Z/C JAR		
SFQ1065J	10G X 65 SUREFAST CSK SQDR Z/C JAR		
SFQ1075J	10G X 75 SUREFAST CSK SQDR Z/C JAR		
SFQ10100J	10G X 100 SUREFAST CSK SQDR Z/C JAR		
TT1225NC4J	12 X 25 HEX W/F TIMBER T17 W/NEO 4 JAR		
TT1235NC4J	12 X 35 HEX W/F TIMBER T17 W/NEO 4 JAR		
TT1245NC4J	12 X 45 HEX W/F TIMBER T17 W/NEO 4 JAR		
TT1255NC4J	12 X 55 HEX W/F TIMBER T17 W/NEO 4 JAR		
TT1265NC4J	12 X 65 HEX W/F TIMBER T17 W/NEO 4 JAR		
TT1275NC4J	14 X 75 HEX W/F TIMBER T17 W/NEO 4 JAR		
TT1490NC4J	14 X 90 HEX W/F TIMBER T17 W/NEO 4 JAR		
TK1220NC4J	12-14 X 20 HEX W/F METAL TEK W/NEO 4 JAR		
TK1225NC4J	12-14 X 25 HEX W/F METAL TEK W/NEO 4 JAR		
TK1235NC4J	12-14 X 35 HEX W/F METAL TEK W/NEO 4 JAR		
TK1245NC4J	12-14 X 45 HEX W/F METAL TEK W/NEO 4 JAR		
TK1255NC4J	12-14 X 55 HEX W/F METAL TEK W/NEO 4 JAR		
TK1265NC4J	12-14 X 65 HEX W/F METAL TEK W/NEO 4 JAR		
TK1475NC4J	12-14 X 75 HEX W/F METAL TEK W/NEO 4 JAR		

PASLODE NAILS

CODE	DESCRIPTION	UNIT	PRICE
PASLODE NAILS			
B20550	PASLODE 90 X 3.15MM B D-HEAD 1000		
B20550V	PASLODE 90 X 315MM B D-HEAD 3000		
B20558	PASLODE 65 X 2.87MMDF GALV R D 1000		
B20568V	PASLODE 65 X 2.87MM HD GALV D-HEAD 3000		
B20571	PASLODE 90 X 3.15MM HD GALV D-HEAD 1000		
B20571V	PASLODE 90 X 3.15MM HD GALV D-HEAD 3000		

CODE DESCRIPTION

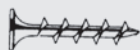

LOOSE
NEEDLE POINT
GYPSUM
SCREWS

LOOSE NEEDLE POINT GYPSUM SCREWS

LCNG25	LOOSE COARSE GYPSUM NEEDLE POINT 6G X 25MM
LFNG25	LOOSE FINE GYPSUM NEEDLE POINT 6G X 25MM
LCNG30	LOOSE COARSE GYPSUM NEEDLE POINT 6G X 30MM
LFNG30	LOOSE FINE GYPSUM NEEDLE POINT 6G X 30MM
LCNG40	LOOSE COARSE GYPSUM NEEDLE POINT 6G X 40MM
LFNG40	LOOSE FINE GYPSUM NEEDLE POINT 6G X 40MM
LCNG45	LOOSE COARSE GYPSUM NEEDLE POINT 6G X 45MM
LFNG45	LOOSE FINE GYPSUM NEEDLE POINT 6G X 45MM



LOOSE DRILL
POINT
GYPSUM
SCREWS

LOOSE DRILL POINT GYPSUM SCREWS

LCDPG25	LOOSE COARSE GYPSUM DRILL POINT 6G X 25MM
LFDPG25	LOOSE FINE GYPSUM DRILL POINT 6G X 25MM
LCDPG30	LOOSE COARSE GYPSUM DRILL POINT 6G X 30MM
LFDPG30	LOOSE FINE GYPSUM DRILL POINT 6G X 30MM
LCDPG40	LOOSE COARSE GYPSUM DRILL POINT 6G X 40MM
LFDPG40	LOOSE FINE GYPSUM DRILL POINT 6G X 40MM
LCDPG45	LOOSE COARSE GYPSUM DRILL POINT 6G X 45MM
LFDPG45	LOOSE FINE GYPSUM DRILL POINT 6G X 45MM



COLLATED
NEEDLE POINT
GYPSUM
SCREWS

COLLATED NEEDLE POINT GYPSUM SCREWS

CCNG25	COLLATED COARSE NEEDLE POINT GYPSUM 6G X 25MM
CFNG25	COLLATED FINE NEEDLE POINT GYPSUM 6G X 25MM
CCNG30	COLLATED COARSE NEEDLE POINT GYPSUM 6G X 30MM
CFNG30	COLLATED FINE NEEDLE POINT GYPSUM 6G X 30MM
CCNG40	COLLATED COARSE NEEDLE POINT GYPSUM 6G X 40MM
CFNG40	COLLATED FINE NEEDLE POINT GYPSUM 6G X 40MM
CCNG45	COLLATED COARSE NEEDLE POINT GYPSUM 6G X 45MM
CFNG45	COLLATED FINE NEEDLE POINT GYPSUM 6G X 45MM



COLLATED DRILL
POINT
GYPSUM
SCREWS

COLLATED DRILL POINT GYPSUM SCREWS

CCDPG25	COLLATED COARSE DRILL POINT GYPSUM 6G X 25MM
CFDPG25	COLLATED FINE DRILL POINT GYPSUM 6G X 25MM
CCDPG30	COLLATED COARSE DRILL POINT GYPSUM 6G X 30MM
CFDPG30	COLLATED FINE DRILL POINT GYPSUM 6G X 30MM
CCDPG40	COLLATED COARSE DRILL POINT GYPSUM 6G X 40MM
CFDPG40	COLLATED FINE DRILL POINT GYPSUM 6G X 40MM
CCDPG45	COLLATED COARSE DRILL POINT GYPSUM 6G X 45MM
CFDPG45	COLLATED FINE DRILL POINT GYPSUM 6G X 45MM



BUTTON HEAD
WAFER TEX
SCREWS

BUTTON HEAD WAFER TEX SCREWS

BHTS	8 -18 X 16 BUTTON HEAD TEX SCREW
------	----------------------------------



35 WOOKEY LANE, KUMEU, NEW ZEALAND

PHONE: +64 9 412 2963

EMAIL: brendon@cbsgroup.co.nz



HELPING BUILD NZ | COMMERCIAL BUILDING SUPPLIES | CBSGROUP.CO.NZ